

# LA FORMA. ANÁLISIS DE LA FORMA TRIDIMENSIONAL

Nombre, apellidos y grupo: .....

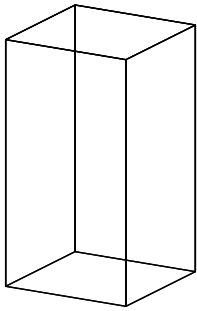

**PARALELEPÍPEDO**

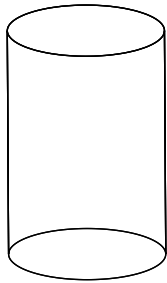

**CILINDRO RECTO**

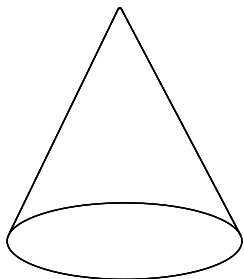

**CONO RECTO**

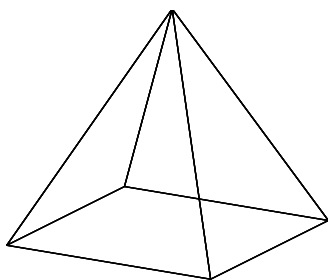

**PIRÁMIDE RECTA**

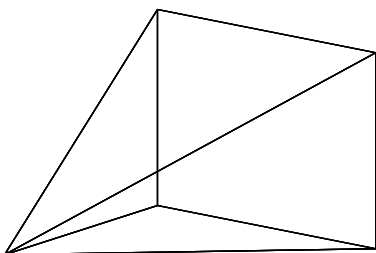
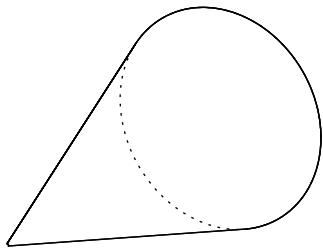
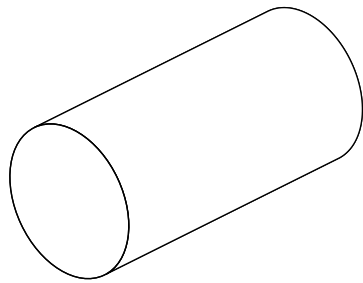
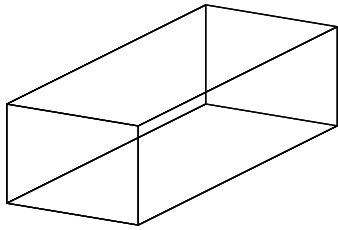

# LA FORMA. ANÁLISIS DE LA FORMA TRIDIMENSIONAL

Nombre, apellidos y grupo: .....



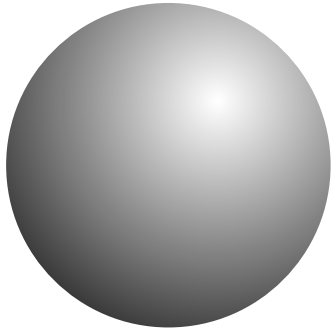

# LA FORMA. ANÁLISIS DE LA FORMA TRIDIMENSIONAL

Nombre, apellidos y grupo: .....

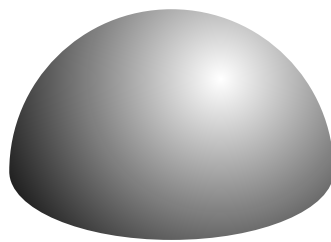
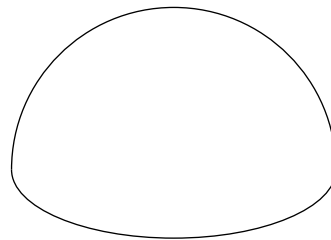
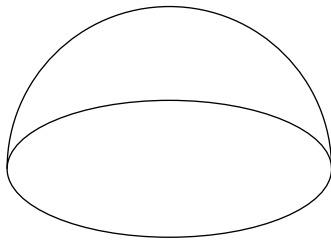
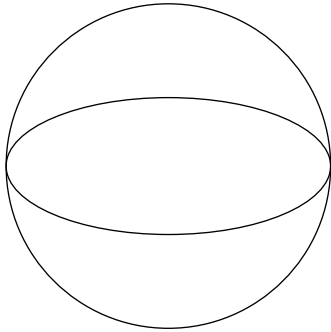

ESFERA



SECCIÓN DE ESFERA. SEMIESFERA

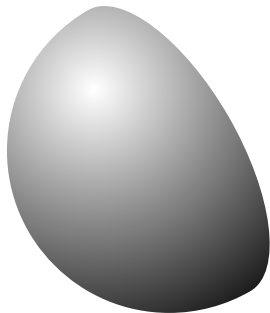
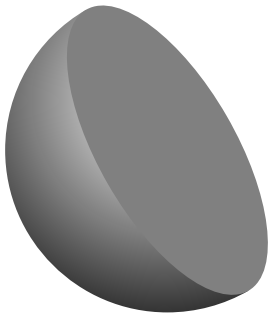
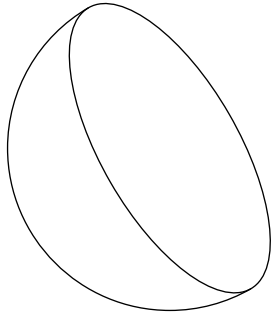
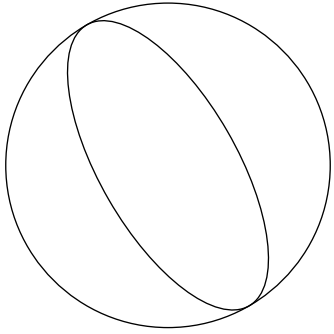

# LA FORMA. ANÁLISIS DE LA FORMA TRIDIMENSIONAL

Nombre, apellidos y grupo: .....



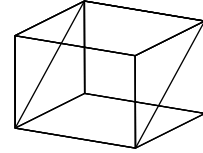
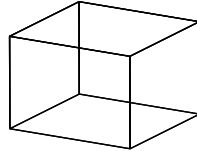
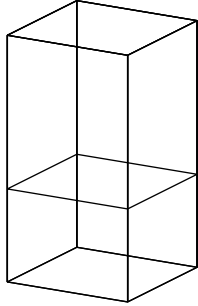

# LA FORMA. ANÁLISIS DE LA FORMA TRIDIMENSIONAL

Nombre, apellidos y grupo: .....

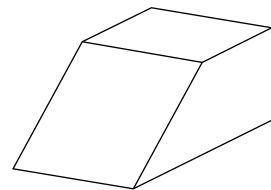
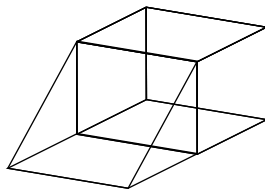
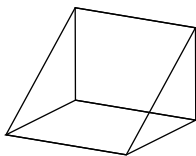

--	--	--



--	--	--

# LA FORMA. ANÁLISIS DE LA FORMA TRIDIMENSIONAL

## SECCIONES Y COMPOSICIÓN A PARTIR DE UN PARALELEPÍPEDO.

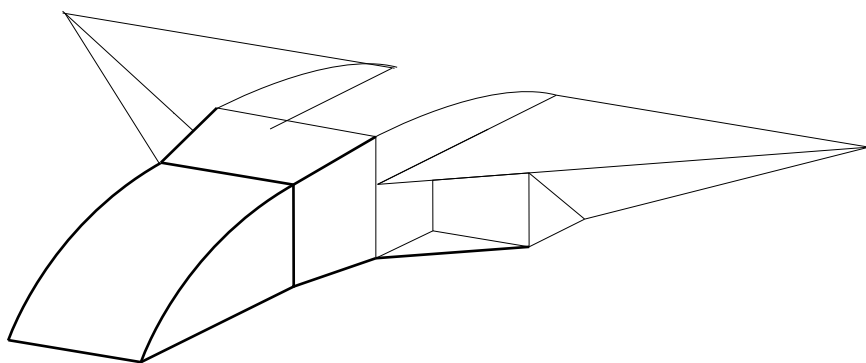
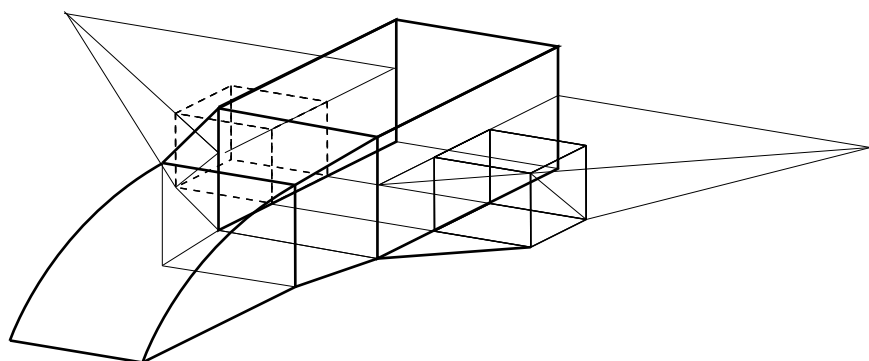
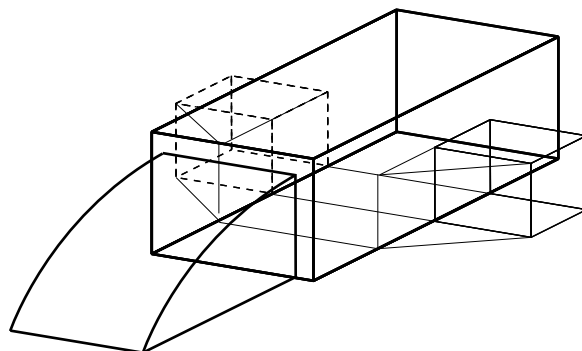
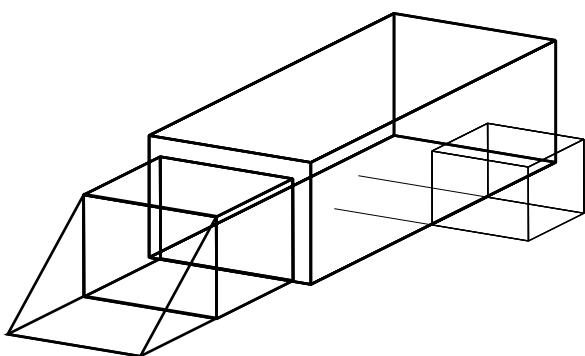

# LA FORMA. ANÁLISIS DE LA FORMA TRIDIMENSIONAL

## SECCIONES Y COMPOSICIÓN A PARTIR DE UN PARALELEPÍPEDO.

